

Color	Type	Technology	Case
Green	G-525-550/D	InGaN	5 mm plastic lens, water clear

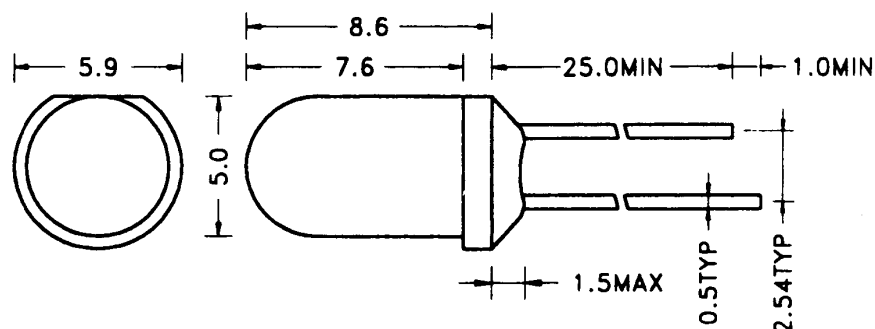

Maximum Ratings at $T_a = 25^\circ\text{C}$

Parameter	Test conditions	Symbol	Value	Unit
Forward current		I_F	25	mA
Peak forward current	Duty 1/10, $f \leq 10$ kHz	I_{FP}	100	mA
Power dissipation		P_D	100	mW
Reverse voltage	$I_R = 10 \mu\text{A}$	V_R	5	V
Reverse current	$U_R = 5$ V	I_R	10	μA
Electrostatic discharge	Human body model	ESD	150	V
Operating temperature		T_{opr}	-20 to +75	$^\circ\text{C}$
Storage temperature		T_{stg}	-30 to +80	$^\circ\text{C}$
Soldering temperature	5 sec max, 3 mm from body	T_{sol}	260	$^\circ\text{C}$

Optical and Electrical Characteristics at $T_a = 25^\circ\text{C}$

Parameter	Test conditions	Symbol	Min.	Typ.	Max.	Unit
Forward voltage	$I_F = 20$ mA	V_F	2.8	3.1	4.0	V
Luminous intensity	$I_F = 20$ mA	I_V		10000		mcd
Luminous flux	$I_F = 20$ mA	Φ_V		3200		mlm
Radiant power	$I_F = 20$ mA	Φ_e		8.0		mW
Peak wavelength	$I_F = 20$ mA	λ_p		525		nm
Dominant wavelength	$I_F = 20$ mA	λ_d	520	525	530	nm
Spectral halfwidth	$I_F = 20$ mA	$\Delta\lambda$		34		nm
Viewing angle	$I_F = 20$ mA	φ		50		deg.