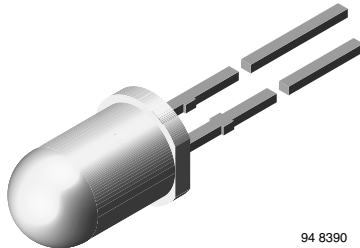


High Speed Infrared Emitting Diode, RoHS Compliant, 870 nm, GaAIAs Double Hetero



94 8390

DESCRIPTION

TSFF5410 is an infrared, 870 nm emitting diode in GaAIAs double hetero (DH) technology with high radiant power and high speed, molded in a clear, untinted plastic package.

FEATURES

- Package type: leaded
- Package form: T-1 $\frac{3}{4}$
- Dimensions (in mm): \varnothing 5
- Leads with stand-off
- Peak wavelength: $\lambda_p = 870$ nm
- High reliability
- High radiant power
- High radiant intensity
- Angle of half intensity: $\varphi = \pm 22^\circ$
- Low forward voltage
- Suitable for high pulse current operation
- High modulation bandwidth: $f_c = 24$ MHz
- Good spectral matching to Si photodetectors
- Lead (Pb)-free component in accordance with RoHS 2002/95/EC and WEEE 2002/96/EC


RoHS
COMPLIANT

APPLICATIONS

- Infrared video data transmission between camcorder and TV set
- Free air data transmission systems with high modulation frequencies or high data transmission rate requirements

PRODUCT SUMMARY

COMPONENT	I_e (mW/sr)	φ (deg)	λ_p (nm)	t_r (ns)
TSFF5410	70	± 22	870	15

Note

Test conditions see table "Basic Characteristics"

ORDERING INFORMATION

ORDERING CODE	PACKAGING	REMARKS	PACKAGE FORM
TSFF5410	Bulk	MOQ: 4000 pcs, 4000 pcs/bulk	T-1 $\frac{3}{4}$

Note

MOQ: minimum order quantity

ABSOLUTE MAXIMUM RATINGS

PARAMETER	TEST CONDITION	SYMBOL	VALUE	UNIT
Reverse voltage		V_R	5	V
Forward current		I_F	100	mA
Peak forward current	$t_p/T = 0.5, t_p = 100 \mu s$	I_{FM}	200	mA
Surge forward current	$t_p = 100 \mu s$	I_{FSM}	1	A
Power dissipation		P_V	180	mW



ABSOLUTE MAXIMUM RATINGS				
PARAMETER	TEST CONDITION	SYMBOL	VALUE	UNIT
Junction temperature		T_j	100	$^{\circ}\text{C}$
Operating temperature range		T_{amb}	- 40 to + 85	$^{\circ}\text{C}$
Storage temperature range		T_{stg}	- 40 to + 100	$^{\circ}\text{C}$
Soldering temperature	$t \leq 5 \text{ s}$, 2 mm from case	T_{sd}	260	$^{\circ}\text{C}$
Thermal resistance junction/ambient	J-STD-051, leads 7 mm, soldered on PCB	R_{thJA}	230	K/W

Note

$T_{\text{amb}} = 25^{\circ}\text{C}$, unless otherwise specified

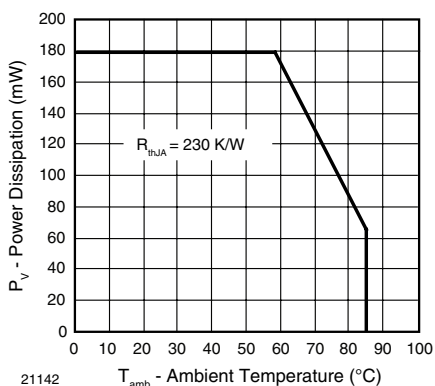


Fig. 1 - Power Dissipation Limit vs. Ambient Temperature

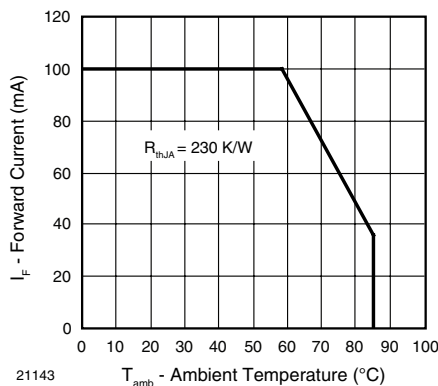


Fig. 2 - Forward Current Limit vs. Ambient Temperature

BASIC CHARACTERISTICS						
PARAMETER	TEST CONDITION	SYMBOL	MIN.	TYP.	MAX.	UNIT
Forward voltage	$I_F = 100 \text{ mA}$, $t_p = 20 \text{ ms}$	V_F		1.5	1.8	V
	$I_F = 1 \text{ A}$, $t_p = 100 \mu\text{s}$	V_F		2.3	3.0	V
Temperature coefficient of V_F	$I_F = 1 \text{ mA}$	TK_{V_F}		- 1.8		mV/K
Reverse current	$V_R = 5 \text{ V}$	I_R			10	μA
Junction capacitance	$V_R = 0 \text{ V}$, $f = 1 \text{ MHz}$, $E = 0$	C_j		125		pF
Radiant intensity	$I_F = 100 \text{ mA}$, $t_p = 20 \text{ ms}$	I_e	45	70	135	mW/sr
	$I_F = 1 \text{ A}$, $t_p = 100 \mu\text{s}$	I_e		700		mW/sr
Radiant power	$I_F = 100 \text{ mA}$, $t_p = 20 \text{ ms}$	ϕ_e		50		mW
Temperature coefficient of ϕ_e	$I_F = 100 \text{ mA}$	TK_{ϕ_e}		- 0.35		%/K
Angle of half intensity		ϕ		± 22		deg
Peak wavelength	$I_F = 100 \text{ mA}$	λ_p		870		nm
Spectral bandwidth	$I_F = 100 \text{ mA}$	$\Delta\lambda$		40		nm
Temperature coefficient of λ_p	$I_F = 100 \text{ mA}$	TK_{λ_p}		0.25		nm/K
Rise time	$I_F = 100 \text{ mA}$	t_r		15		ns
Fall time	$I_F = 100 \text{ mA}$	t_f		15		ns
Cut-off frequency	$I_{\text{DC}} = 70 \text{ mA}$, $I_{\text{AC}} = 30 \text{ mA pp}$	f_c		24		MHz
Virtual source diameter		d		2.1		mm

Note

$T_{\text{amb}} = 25^{\circ}\text{C}$, unless otherwise specified

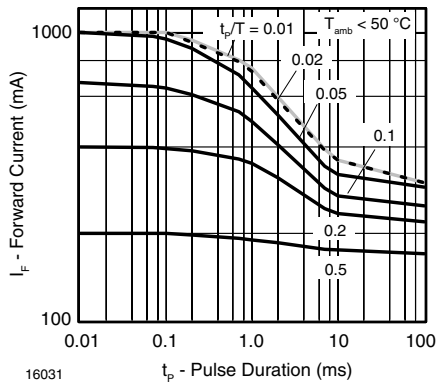
BASIC CHARACTERISTICS
 $T_{amb} = 25\text{ }^{\circ}\text{C}$, unless otherwise specified


Fig. 3 - Pulse Forward Current vs. Pulse Duration

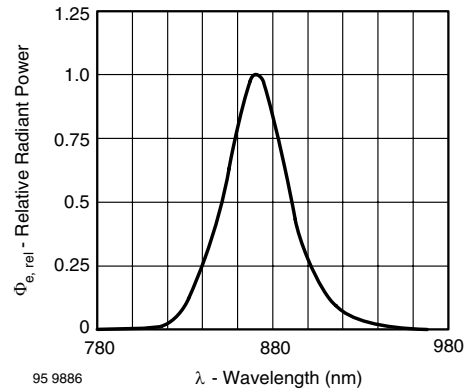


Fig. 6 - Relative Radiant Power vs. Wavelength

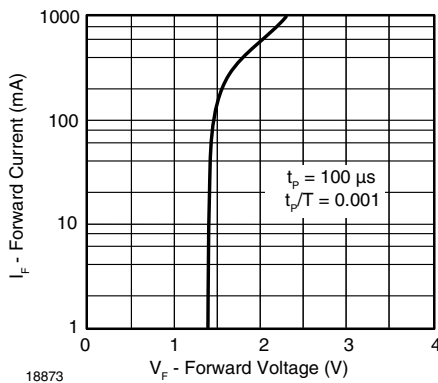


Fig. 4 - Forward Current vs. Forward Voltage

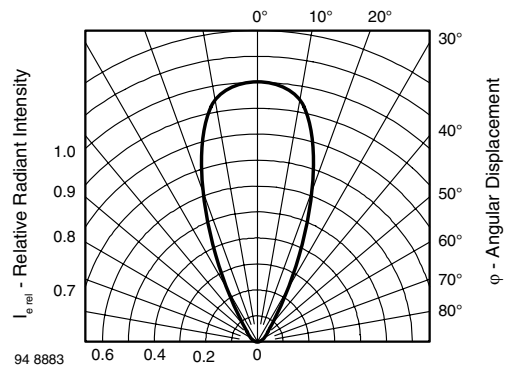


Fig. 7 - Relative Radiant Intensity vs. Angular Displacement

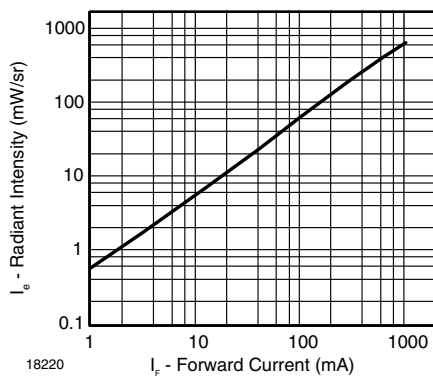


Fig. 5 - Radiant Intensity vs. Forward Current

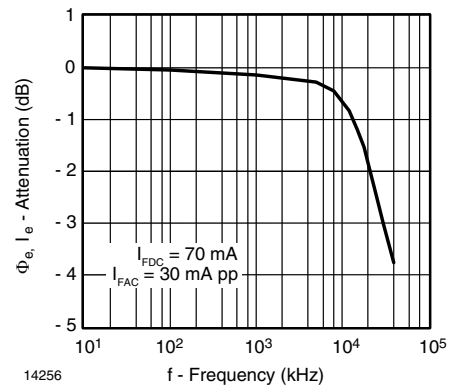


Fig. 8 - Attenuation vs. Frequency

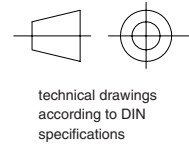
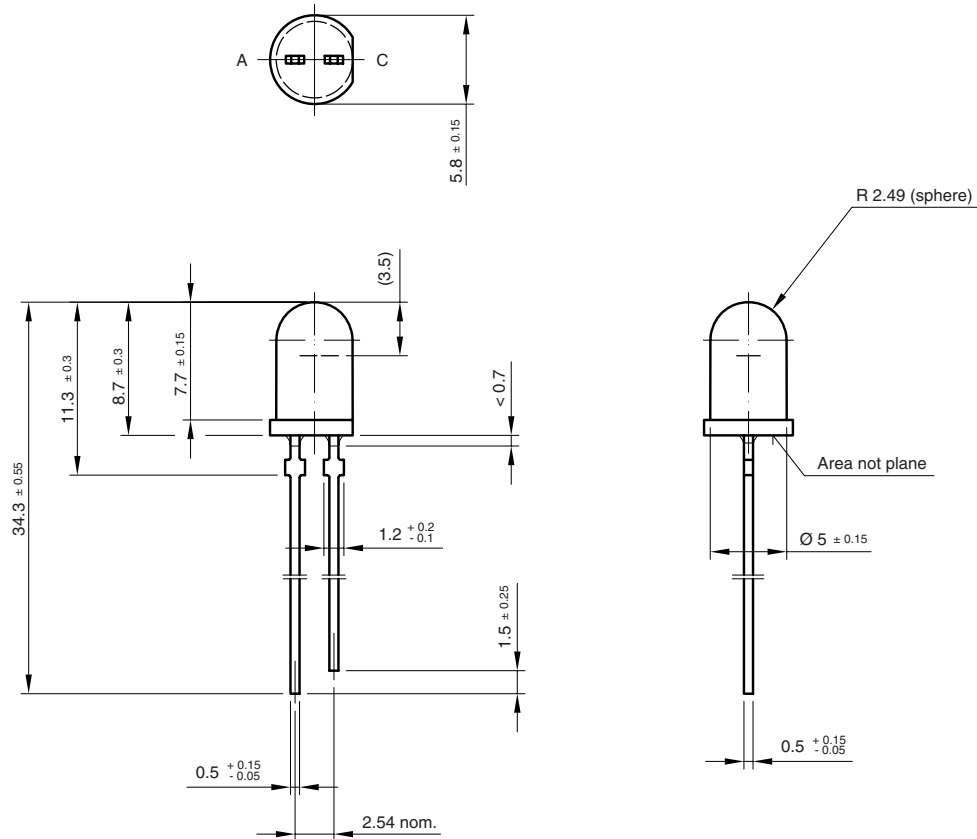
TSFF5410

Vishay Semiconductors

High Speed Infrared Emitting Diode, RoHS Compliant, 870 nm, GaAlAs Double Hetero



PACKAGE DIMENSIONS in millimeters



6.544-5258.06-4
Issue: 2; 08.11.99
95 11260



Disclaimer

All product specifications and data are subject to change without notice.

Vishay Intertechnology, Inc., its affiliates, agents, and employees, and all persons acting on its or their behalf (collectively, "Vishay"), disclaim any and all liability for any errors, inaccuracies or incompleteness contained herein or in any other disclosure relating to any product.

Vishay disclaims any and all liability arising out of the use or application of any product described herein or of any information provided herein to the maximum extent permitted by law. The product specifications do not expand or otherwise modify Vishay's terms and conditions of purchase, including but not limited to the warranty expressed therein, which apply to these products.

No license, express or implied, by estoppel or otherwise, to any intellectual property rights is granted by this document or by any conduct of Vishay.

The products shown herein are not designed for use in medical, life-saving, or life-sustaining applications unless otherwise expressly indicated. Customers using or selling Vishay products not expressly indicated for use in such applications do so entirely at their own risk and agree to fully indemnify Vishay for any damages arising or resulting from such use or sale. Please contact authorized Vishay personnel to obtain written terms and conditions regarding products designed for such applications.

Product names and markings noted herein may be trademarks of their respective owners.