

## Infrared Emitting Diode, RoHS Compliant, 875 nm, GaAlAs

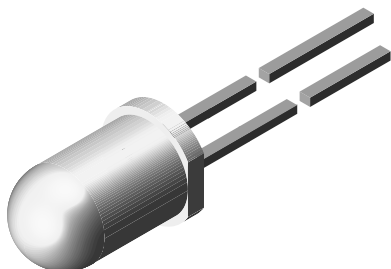

94 8389

### DESCRIPTION

The TSHA650. series are infrared, 875 nm emitting diodes in GaAlAs technology, molded in a clear, untinted plastic package.

### FEATURES

- Package type: leaded
- Package form: T-1 $\frac{3}{4}$
- Dimensions (in mm):  $\varnothing$  5
- Peak wavelength:  $\lambda_p = 875$  nm
- High reliability
- Angle of half intensity:  $\varphi = \pm 24^\circ$
- Low forward voltage
- Suitable for high pulse current operation
- Good spectral matching with Si photodetectors
- Lead (Pb)-free component in accordance with RoHS 2002/95/EC and WEEE 2002/96/EC



**RoHS**  
COMPLIANT

### APPLICATIONS

- Infrared remote control and free air data transmission systems with comfortable radiation angle
- This emitter series is dedicated to systems with panes in transmission space between emitter and detector, because of the low absorption of 875 nm radiation in glass

### PRODUCT SUMMARY

COMPONENT	$I_e$ (mW/sr)	$\varphi$ (deg)	$\lambda_p$ (nm)	$t_r$ (ns)
TSHA6500	20	$\pm 24$	875	600
TSHA6501	25	$\pm 24$	875	600
TSHA6502	30	$\pm 24$	875	600
TSHA6503	35	$\pm 24$	875	600

#### Note

Test conditions see table "Basic Characteristics"

### ORDERING INFORMATION

ORDERING CODE	PACKAGING	REMARKS	PACKAGE FORM
TSHA6500	Bulk	MOQ: 4000 pcs, 4000 pcs/bulk	T-1 $\frac{3}{4}$
TSHA6501	Bulk	MOQ: 4000 pcs, 4000 pcs/bulk	T-1 $\frac{3}{4}$
TSHA6502	Bulk	MOQ: 4000 pcs, 4000 pcs/bulk	T-1 $\frac{3}{4}$
TSHA6503	Bulk	MOQ: 4000 pcs, 4000 pcs/bulk	T-1 $\frac{3}{4}$

#### Note

MOQ: minimum order quantity

### ABSOLUTE MAXIMUM RATINGS

PARAMETER	TEST CONDITION	SYMBOL	VALUE	UNIT
Reverse voltage		$V_R$	5	V
Forward current		$I_F$	100	mA
Peak forward current	$t_p/T = 0.5, t_p = 100 \mu s$	$I_{FM}$	200	mA
Surge forward current	$t_p = 100 \mu s$	$I_{FSM}$	2.5	A
Power dissipation		$P_V$	180	mW



# TSHA6500, TSHA6501, TSHA6502, TSHA6503

Infrared Emitting Diode, RoHS Compliant, Vishay Semiconductors  
875 nm, GaAlAs

ABSOLUTE MAXIMUM RATINGS				
PARAMETER	TEST CONDITION	SYMBOL	VALUE	UNIT
Junction temperature		$T_j$	100	$^{\circ}\text{C}$
Operating temperature range		$T_{\text{amb}}$	- 40 to + 85	$^{\circ}\text{C}$
Storage temperature range		$T_{\text{stg}}$	- 40 to + 100	$^{\circ}\text{C}$
Soldering temperature	$t \leq 5$ s, 2 mm from case	$T_{\text{sd}}$	260	$^{\circ}\text{C}$
Thermal resistance junction/ambient	J-STD-051, leads 7 mm, soldered on PCB	$R_{\text{thJA}}$	230	K/W

**Note**

$T_{\text{amb}} = 25^{\circ}\text{C}$ , unless otherwise specified

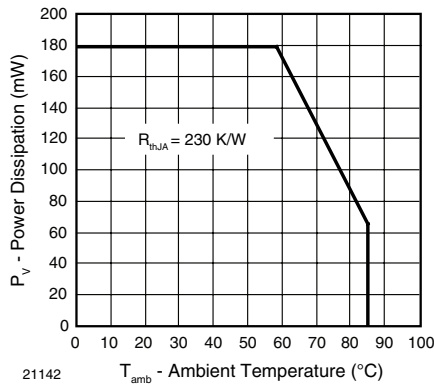

Fig. 1 - Power Dissipation Limit vs. Ambient Temperature

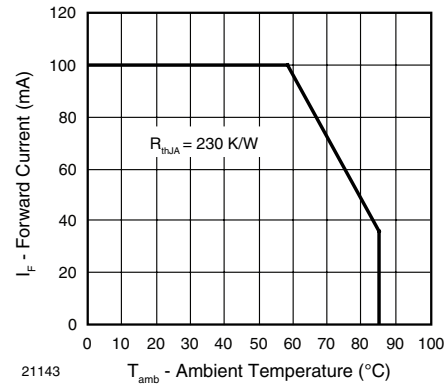

Fig. 2 - Forward Current Limit vs. Ambient Temperature

BASIC CHARACTERISTICS						
PARAMETER	TEST CONDITION	SYMBOL	MIN.	TYP.	MAX.	UNIT
Forward voltage	$I_F = 100$ mA, $t_p = 20$ ms	$V_F$		1.5	1.8	V
Temperature coefficient of $V_F$	$I_F = 100$ mA	$\text{TK}_{V_F}$		- 1.6		mV/K
Reverse current	$V_R = 5$ V	$I_R$			100	$\mu\text{A}$
Junction capacitance	$V_R = 0$ V, $f = 1$ MHz, $E = 0$	$C_j$		20		pF
Temperature coefficient of $\phi_e$	$I_F = 20$ mA	$\text{TK}_{\phi_e}$		- 0.7		%/K
Angle of half intensity		$\varphi$		$\pm 24$		deg
Peak wavelength	$I_F = 100$ mA	$\lambda_p$		875		nm
Spectral bandwidth	$I_F = 100$ mA	$\Delta\lambda$		80		nm
Temperature coefficient of $\lambda_p$	$I_F = 100$ mA	$\text{TK}_{\lambda_p}$		0.2		nm/K
Rise time	$I_F = 100$ mA	$t_r$		600		ns
	$I_F = 1.5$ A	$t_r$		300		ns
Fall time	$I_F = 100$ mA	$t_f$		600		ns
	$I_F = 1.5$ A	$t_f$		300		ns
Virtual source diameter		$d$		2.2		mm

**Note**

$T_{\text{amb}} = 25^{\circ}\text{C}$ , unless otherwise specified

# TSHA6500, TSHA6501, TSHA6502, TSHA6503



Vishay Semiconductors Infrared Emitting Diode, RoHS Compliant,  
875 nm, GaAlAs

TYPE DEDICATED CHARACTERISTICS							
PARAMETER	TEST CONDITION	PART	SYMBOL	MIN.	TYP.	MAX.	UNIT
Forward voltage	$I_F = 1.5 \text{ A}$ , $t_p = 100 \mu\text{s}$	TSHA6500	$V_F$		3.2	4.9	V
		TSHA6501	$V_F$		3.2	4.9	V
		TSHA6502	$V_F$		3.2	4.5	V
		TSHA6503	$V_F$		3.2	4.5	V
Radiant intensity	$I_F = 100 \text{ mA}$ , $t_p = 20 \text{ ms}$	TSHA6500	$I_e$	12	20	60	mW/sr
		TSHA6501	$I_e$	16	25	60	mW/sr
		TSHA6502	$I_e$	20	30	60	mW/sr
		TSHA6503	$I_e$	24	35	60	mW/sr
	$I_F = 1.5 \text{ A}$ , $t_p = 100 \mu\text{s}$	TSHA6500	$I_e$	150	240		mW/sr
		TSHA6501	$I_e$	200	300		mW/sr
		TSHA6502	$I_e$	250	360		mW/sr
		TSHA6503	$I_e$	300	420		mW/sr
Radiant power	$I_F = 100 \text{ mA}$ , $t_p = 20 \text{ ms}$	TSHA6500	$\phi_e$		22		mW
		TSHA6501	$\phi_e$		23		mW
		TSHA6502	$\phi_e$		24		mW
		TSHA6503	$\phi_e$		25		mW

**Note**

$T_{amb} = 25 \text{ }^\circ\text{C}$ , unless otherwise specified

**BASIC CHARACTERISTICS**

$T_{amb} = 25 \text{ }^\circ\text{C}$ , unless otherwise specified

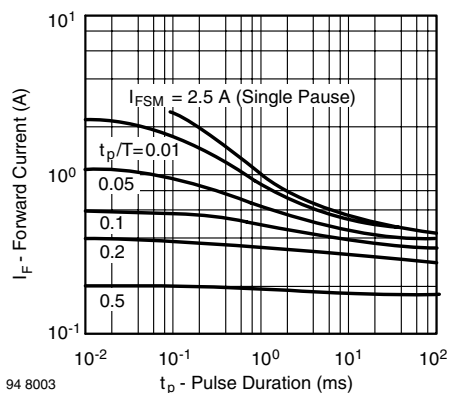

Fig. 3 - Pulse Forward Current vs. Pulse Duration

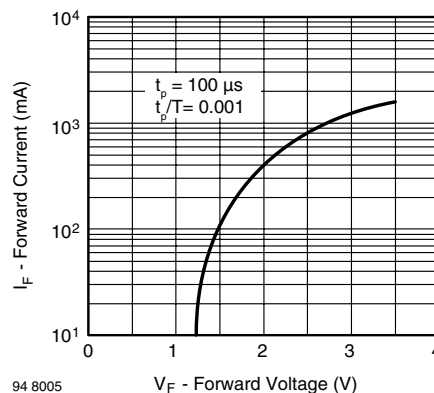

Fig. 4 - Forward Current vs. Forward Voltage



# TSHA6500, TSHA6501, TSHA6502, TSHA6503

Infrared Emitting Diode, RoHS Compliant, Vishay Semiconductors  
875 nm, GaAlAs

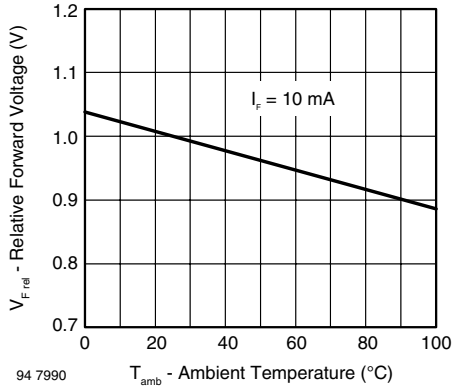

Fig. 5 - Relative Forward Voltage vs. Ambient Temperature

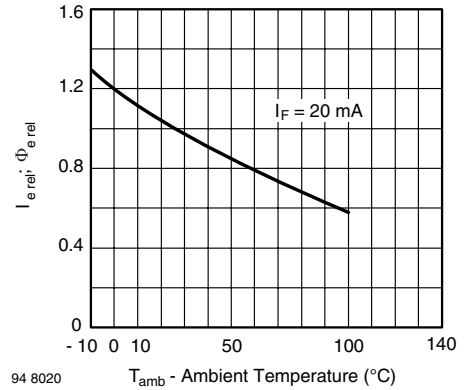

Fig. 8 - Relative Radiant Intensity/Power vs. Ambient Temperature

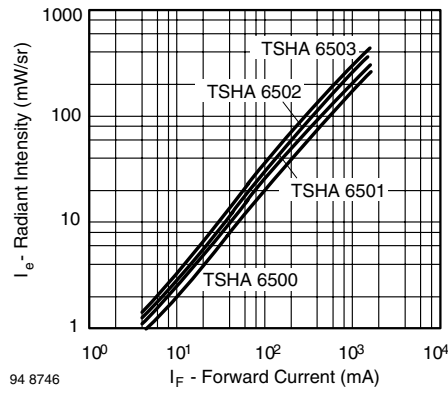

Fig. 6 - Radiant Intensity vs. Forward Current

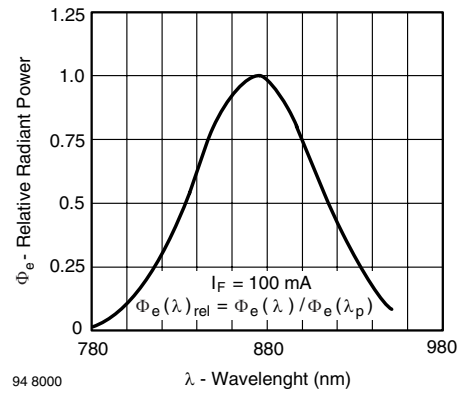

Fig. 9 - Relative Radiant Power vs. Wavelength

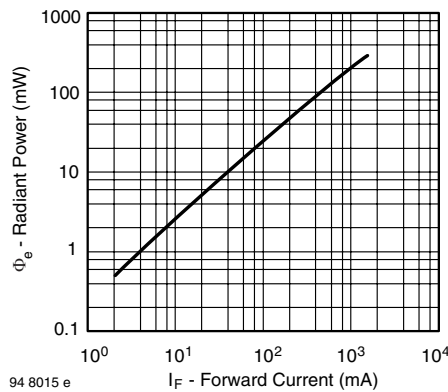

Fig. 7 - Radiant Power vs. Forward Current

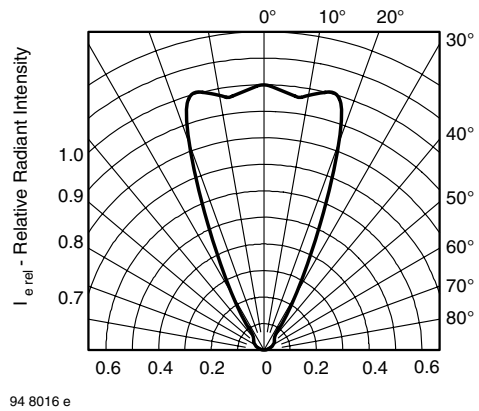

Fig. 10 - Relative Radiant Intensity vs. Angular Displacement

# TSHA6500, TSHA6501, TSHA6502, TSHA6503

Vishay Semiconductors

Infrared Emitting Diode, RoHS Compliant,  
875 nm, GaAlAs



## PACKAGE DIMENSIONS in millimeters

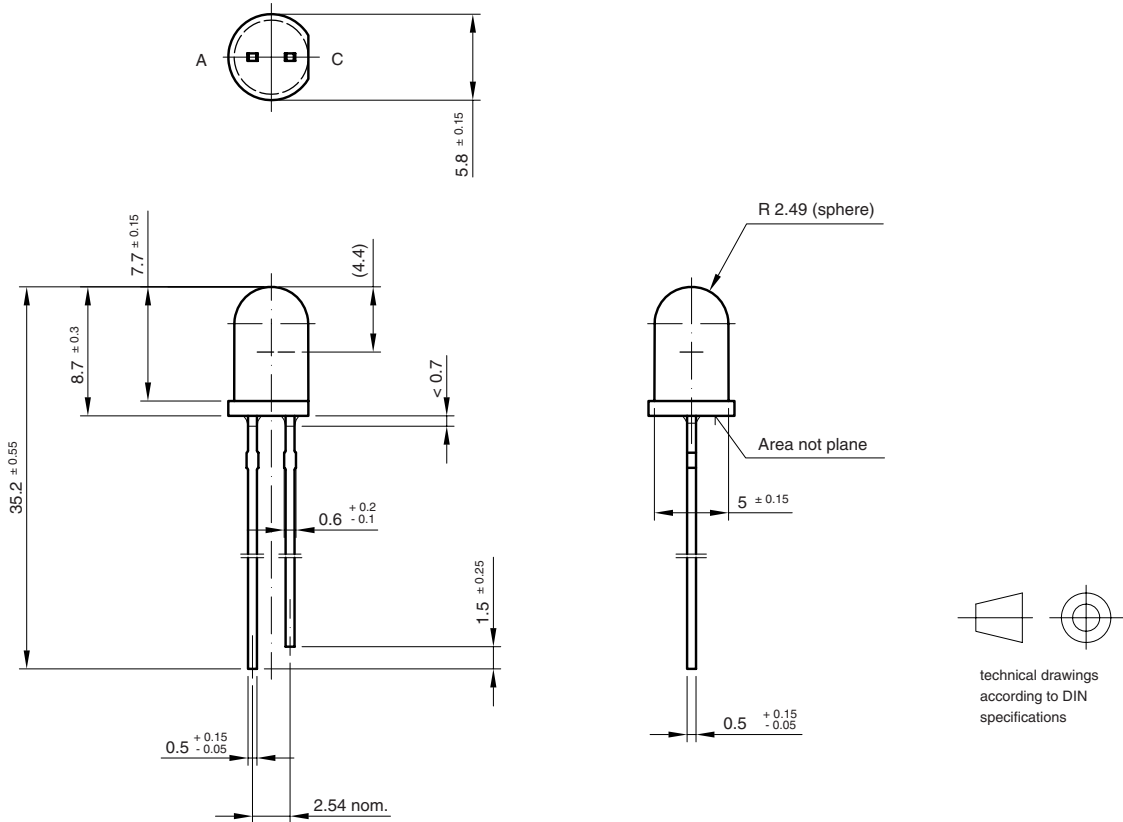

6.544-5259.08-4  
Issue: 2; 25.08.98  
14436



## Disclaimer

All product specifications and data are subject to change without notice.

Vishay Intertechnology, Inc., its affiliates, agents, and employees, and all persons acting on its or their behalf (collectively, "Vishay"), disclaim any and all liability for any errors, inaccuracies or incompleteness contained herein or in any other disclosure relating to any product.

Vishay disclaims any and all liability arising out of the use or application of any product described herein or of any information provided herein to the maximum extent permitted by law. The product specifications do not expand or otherwise modify Vishay's terms and conditions of purchase, including but not limited to the warranty expressed therein, which apply to these products.

No license, express or implied, by estoppel or otherwise, to any intellectual property rights is granted by this document or by any conduct of Vishay.

The products shown herein are not designed for use in medical, life-saving, or life-sustaining applications unless otherwise expressly indicated. Customers using or selling Vishay products not expressly indicated for use in such applications do so entirely at their own risk and agree to fully indemnify Vishay for any damages arising or resulting from such use or sale. Please contact authorized Vishay personnel to obtain written terms and conditions regarding products designed for such applications.

Product names and markings noted herein may be trademarks of their respective owners.