

## Infrared Emitting Diode, RoHS Compliant, 950 nm, GaAs

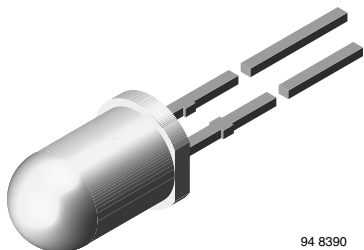

94 8390

### DESCRIPTION

TSUS5200 is an infrared, 950 nm emitting diode in GaAs technology molded in a blue-gray tinted plastic package.

### FEATURES

- Package type: leaded
- Package form: T-1 $\frac{3}{4}$
- Dimensions (in mm):  $\varnothing$  5
- Leads with stand-off
- Peak wavelength:  $\lambda_p = 950$  nm
- High reliability
- Angle of half intensity:  $\varphi = \pm 15^\circ$
- Low forward voltage
- Suitable for high pulse current operation
- Good spectral matching with Si photodetectors
- Lead (Pb)-free component in accordance with RoHS 2002/95/EC and WEEE 2002/96/EC



**RoHS**  
COMPLIANT

### APPLICATIONS

- Infrared remote control and free air transmission systems with low forward voltage and small package requirements
- Emitter in transmissive sensors
- Emitter in reflective sensors

### PRODUCT SUMMARY

COMPONENT	$I_e$ (mW/sr)	$\varphi$ (deg)	$\lambda_p$ (nm)	$t_r$ (ns)
TSUS5200	20	$\pm 15$	950	800
TSUS5201	25	$\pm 15$	950	800
TSUS5202	30	$\pm 15$	950	800

**Note**

Test conditions see table "Basic Characteristics"

### ORDERING INFORMATION

ORDERING CODE	PACKAGING	REMARKS	PACKAGE FORM
TSUS5200	Bulk	MOQ: 4000 pcs, 4000 pcs/bulk	T-1 $\frac{3}{4}$
TSUS5201	Bulk	MOQ: 4000 pcs, 4000 pcs/bulk	T-1 $\frac{3}{4}$
TSUS5202	Bulk	MOQ: 4000 pcs, 4000 pcs/bulk	T-1 $\frac{3}{4}$

**Note**

MOQ: minimum order quantity

### ABSOLUTE MAXIMUM RATINGS

PARAMETER	TEST CONDITION	SYMBOL	VALUE	UNIT
Reverse voltage		$V_R$	5	V
Forward current		$I_F$	150	mA
Peak forward current	$t_p/T = 0.5, t_p = 100 \mu s$	$I_{FM}$	300	mA
Surge forward current	$t_p = 100 \mu s$	$I_{FSM}$	2.5	A
Power dissipation		$P_V$	170	mW
Junction temperature		$T_j$	100	$^\circ C$
Operating temperature range		$T_{amb}$	- 40 to + 85	$^\circ C$
Storage temperature range		$T_{stg}$	- 40 to + 100	$^\circ C$
Soldering temperature	$t \leq 5$ s, 2 mm from case	$T_{sd}$	260	$^\circ C$
Thermal resistance junction/ambient	J-STD-051, leads 7 mm, soldered on PCB	$R_{thJA}$	230	K/W

**Note**

$T_{amb} = 25$   $^\circ C$ , unless otherwise specified



# TSUS5200, TSUS5201, TSUS5202

Infrared Emitting Diode, RoHS Compliant, Vishay Semiconductors  
950 nm, GaAs

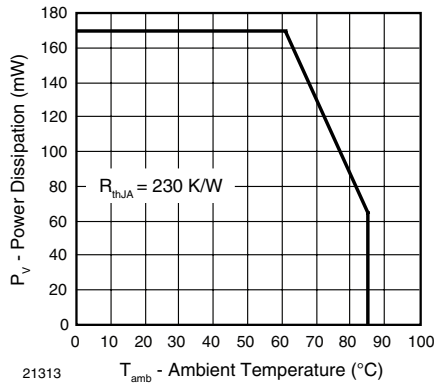

Fig. 1 - Power Dissipation Limit vs. Ambient Temperature

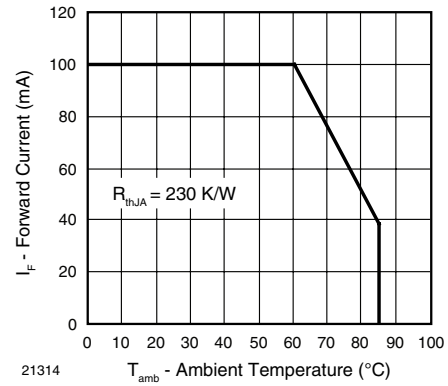

Fig. 2 - Forward Current Limit vs. Ambient Temperature

BASIC CHARACTERISTICS						
PARAMETER	TEST CONDITION	SYMBOL	MIN.	TYP.	MAX.	UNIT
Forward voltage	I <sub>F</sub> = 100 mA, t <sub>p</sub> = 20 ms	V <sub>F</sub>		1.3	1.7	V
Temperature coefficient of V <sub>F</sub>	I <sub>F</sub> = 100 mA	TK <sub>V<sub>F</sub></sub>		- 1.3		mV/K
Reverse current	V <sub>R</sub> = 5 V	I <sub>R</sub>			100	μA
Junction capacitance	V <sub>R</sub> = 0 V, f = 1 MHz, E = 0	C <sub>j</sub>		30		pF
Temperature coefficient of φ <sub>e</sub>	I <sub>F</sub> = 20 mA	TKφ <sub>e</sub>		- 0.8		%/K
Angle of half intensity		φ		± 15		deg
Peak wavelength	I <sub>F</sub> = 100 mA	λ <sub>p</sub>		950		nm
Spectral bandwidth	I <sub>F</sub> = 100 mA	Δλ		50		nm
Temperature coefficient of λ <sub>p</sub>	I <sub>F</sub> = 100 mA	TKλ <sub>p</sub>		0.2		nm/K
Rise time	I <sub>F</sub> = 100 mA	t <sub>r</sub>		800		ns
	I <sub>F</sub> = 1.5 A	t <sub>r</sub>		400		ns
Fall time	I <sub>F</sub> = 100 mA	t <sub>f</sub>		800		ns
	I <sub>F</sub> = 1.5 A	t <sub>f</sub>		400		ns
Virtual source diameter		d		3.8		mm

**Note**

T<sub>amb</sub> = 25 °C, unless otherwise specified

TYPE DEDICATED CHARACTERISTICS							
PARAMETER	TEST CONDITION	PART	SYMBOL	MIN.	TYP.	MAX.	UNIT
Forward voltage	$I_F = 1.5 \text{ A}$ , $t_p = 100 \mu\text{s}$	TSUS5200	$V_F$		2.2	3.4	V
		TSUS5201	$V_F$		2.2	3.4	V
		TSUS5202	$V_F$		2.2	2.7	V
Radiant intensity	$I_F = 100 \text{ mA}$ , $t_p = 20 \text{ ms}$	TSUS5200	$I_e$	10	20	50	mW/sr
		TSUS5201	$I_e$	15	25	50	mW/sr
		TSUS5202	$I_e$	20	30	50	mW/sr
	$I_F = 1.5 \text{ A}$ , $t_p = 100 \mu\text{s}$	TSUS5200	$I_e$	95	180		mW/sr
		TSUS5201	$I_e$	120	230		mW/sr
		TSUS5202	$I_e$	170	280		mW/sr
Radiant power	$I_F = 100 \text{ mA}$ , $t_p = 20 \text{ ms}$	TSUS5200	$\phi_e$		13		mW
		TSUS5201	$\phi_e$		14		mW
		TSUS5202	$\phi_e$		15		mW

**Note**

$T_{amb} = 25 \text{ }^\circ\text{C}$ , unless otherwise specified

**BASIC CHARACTERISTICS**

$T_{amb} = 25 \text{ }^\circ\text{C}$ , unless otherwise specified

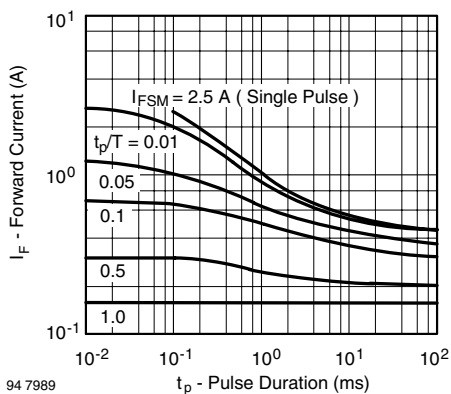

Fig. 3 - Pulse Forward Current vs. Pulse Duration

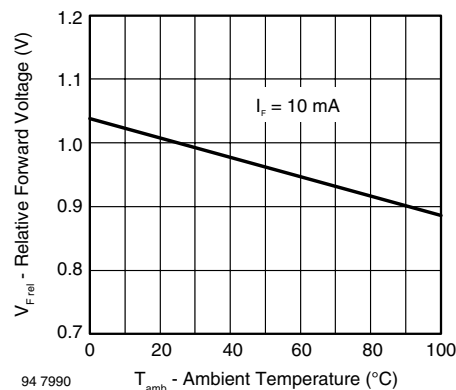

Fig. 5 - Relative Forward Voltage vs. Ambient Temperature

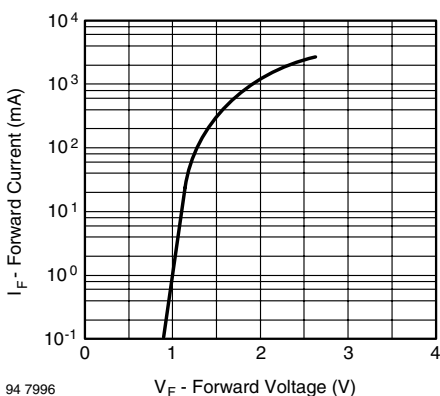

Fig. 4 - Forward Current vs. Forward Voltage

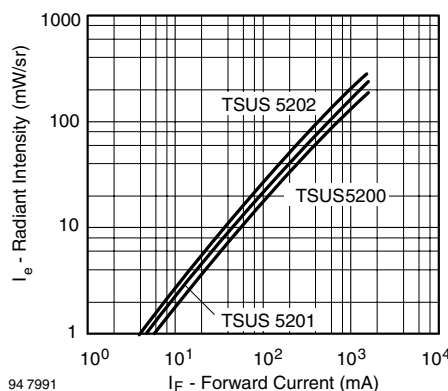
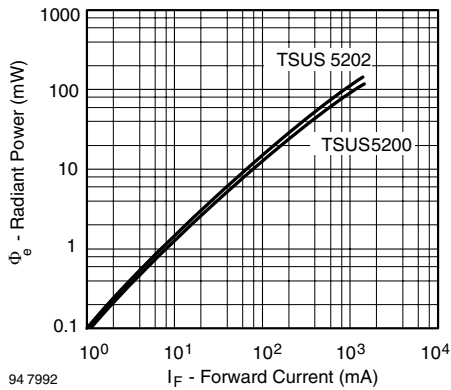

Fig. 6 - Radiant Intensity vs. Forward Current



# TSUS5200, TSUS5201, TSUS5202

Infrared Emitting Diode, RoHS Compliant, Vishay Semiconductors  
950 nm, GaAs



94 7992  
Fig. 7 - Radiant Power vs. Forward Current

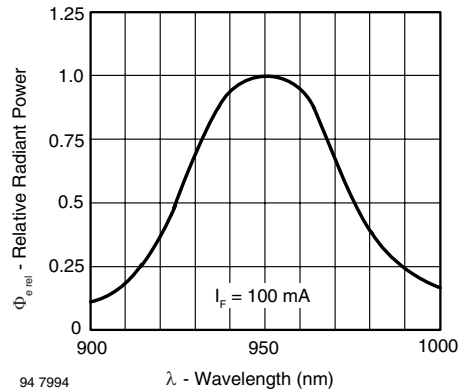

94 7994  
Fig. 9 - Relative Radiant Power vs. Wavelength

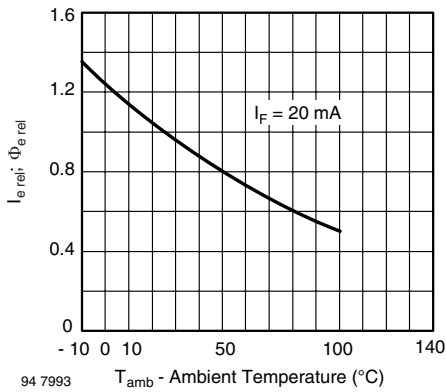

94 7993  
Fig. 8 - Relative Radiant Intensity/Power vs. Ambient Temperature

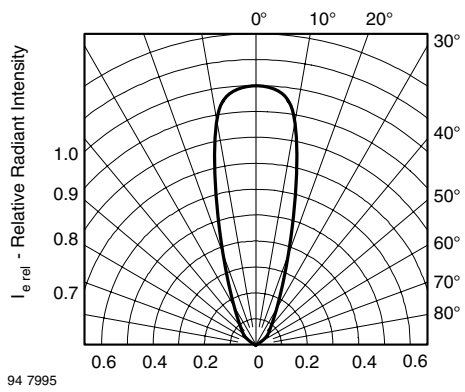

94 7995  
Fig. 10 - Relative Radiant Intensity vs. Angular Displacement

## PACKAGE DIMENSIONS in millimeters

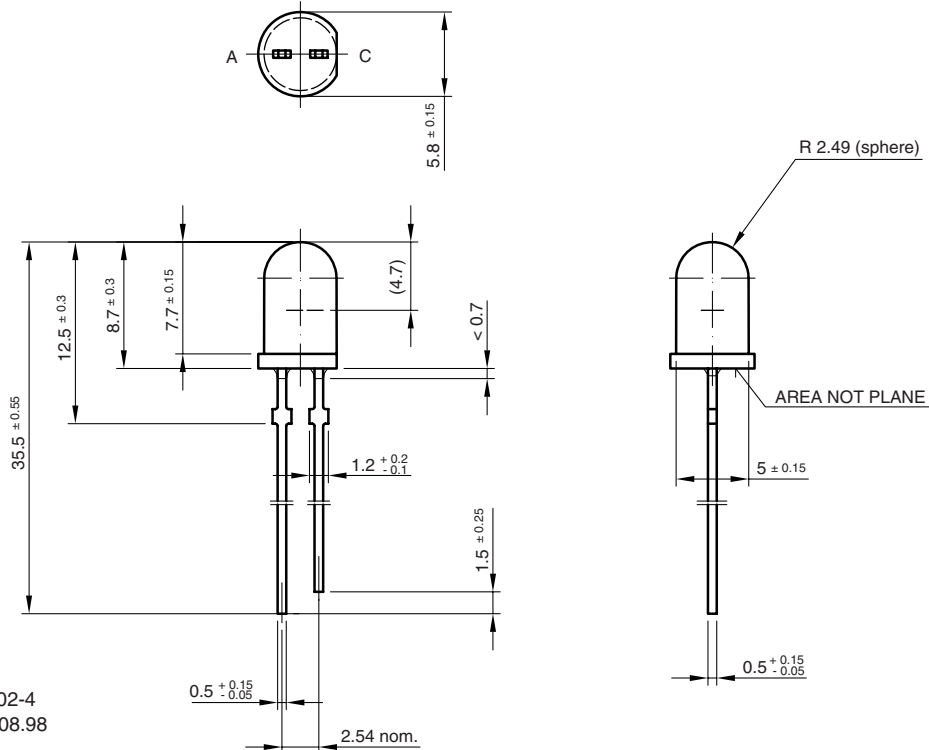

6.544-5258.02-4  
Issue: 5; 03.08.98  
95 10916

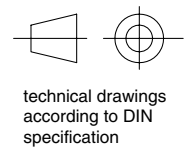



## Disclaimer

All product specifications and data are subject to change without notice.

Vishay Intertechnology, Inc., its affiliates, agents, and employees, and all persons acting on its or their behalf (collectively, "Vishay"), disclaim any and all liability for any errors, inaccuracies or incompleteness contained herein or in any other disclosure relating to any product.

Vishay disclaims any and all liability arising out of the use or application of any product described herein or of any information provided herein to the maximum extent permitted by law. The product specifications do not expand or otherwise modify Vishay's terms and conditions of purchase, including but not limited to the warranty expressed therein, which apply to these products.

No license, express or implied, by estoppel or otherwise, to any intellectual property rights is granted by this document or by any conduct of Vishay.

The products shown herein are not designed for use in medical, life-saving, or life-sustaining applications unless otherwise expressly indicated. Customers using or selling Vishay products not expressly indicated for use in such applications do so entirely at their own risk and agree to fully indemnify Vishay for any damages arising or resulting from such use or sale. Please contact authorized Vishay personnel to obtain written terms and conditions regarding products designed for such applications.

Product names and markings noted herein may be trademarks of their respective owners.