

Color	Type	Technology	Case
White	W-556WD	InGaN/GaN	5 mm plastic lens, white diffused

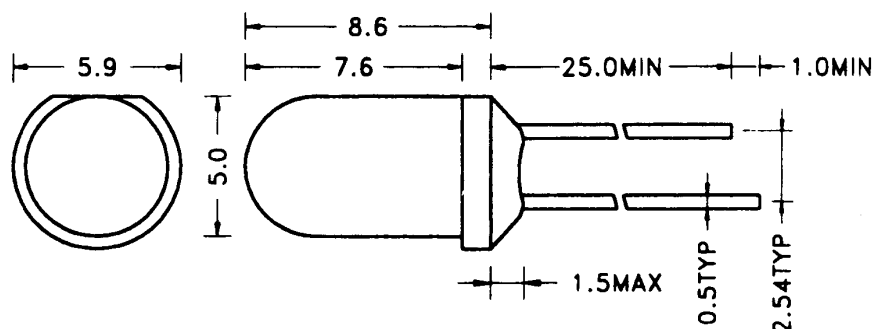

Maximum Ratings at $T_a = 25^\circ\text{C}$

Parameter	Test conditions	Symbol	Value	Unit
Forward current		I_F	30	mA
Peak forward current	Duty 1/10, $f \leq 10$ kHz	I_{FP}	100	mA
Power dissipation		P_D	120	mW
Reverse voltage	$I_R = 10 \mu\text{A}$	V_R	5	V
Reverse current	$U_R = 5$ V	I_R	50	μA
Electrostatic discharge	Human body model	ESD	150	V
Operating temperature		T_{opr}	-20 to +80	$^\circ\text{C}$
Storage temperature		T_{stg}	-30 to +100	$^\circ\text{C}$
Soldering temperature	5 sec max, 2 mm from body	T_{sol}	260	$^\circ\text{C}$

Electrical and Optical Characteristics at $T_a = 25^\circ\text{C}$

Parameter	Test conditions	Symbol	Min.	Typ.	Max.	Unit
Forward voltage	$I_F = 20$ mA	V_F		3.3	4.0	V
Luminous intensity	$I_F = 20$ mA	I_V	1500	2500		mcd
Luminous flux	$I_F = 20$ mA	Φ_V		2100		lm
Radiant power	$I_F = 20$ mA	Φ_e		8.8		mW
Viewing angle	$I_F = 20$ mA	φ		56		deg.