

Color	Type	Technology	Case
Yellow	YH-590-544	AllnGaP/GaP	5 mm plastic lens, water clear

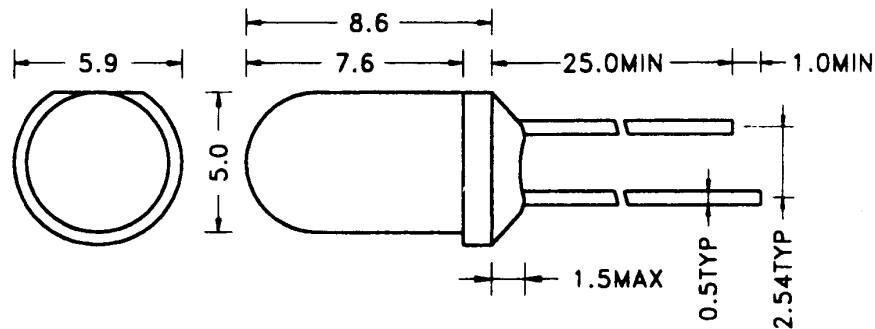

### Maximum Ratings at $T_a = 25^\circ\text{C}$

Parameter	Test conditions	Symbol	Value	Unit
Forward current		$I_F$	50	mA
Peak forward current	Duty 1/10, $f \leq 10$ kHz	$I_{FP}$	100	mA
Power dissipation		$P_D$	130	mW
Reverse voltage	$I_R = 10 \mu\text{A}$	$V_R$	5	V
Reverse current	$U_R = 5$ V	$I_R$	10	$\mu\text{A}$
Electrostatic discharge	Human body model	ESD	2000	V
Operating temperature		$T_{opr}$	-40 to +85	$^\circ\text{C}$
Storage temperature		$T_{stg}$	-40 to +100	$^\circ\text{C}$
Soldering temperature	5 sec max, 2 mm from body	$T_{sol}$	260	$^\circ\text{C}$

### Optical and Electrical Characteristics at $T_a = 25^\circ\text{C}$

Parameter	Test conditions	Symbol	Min.	Typ.	Max.	Unit
Forward voltage	$I_F = 20$ mA	$V_F$	1.7	2.4	2.6	V
Luminous intensity	$I_F = 20$ mA	$I_V$		2100		mcd
Luminous flux	$I_F = 20$ mA	$\Phi_V$		1200		mlm
Radiant power	$I_F = 20$ mA	$\Phi_e$		3.0		mW
Peak wavelength	$I_F = 20$ mA	$\lambda_p$		590		nm
Dominant wavelength	$I_F = 20$ mA	$\lambda_d$		590		nm
Spectral halfwidth	$I_F = 20$ mA	$\Delta\lambda$		20		nm
Viewing angle	$I_F = 20$ mA	$\varphi$		44		deg.