

# IR-945-524N1

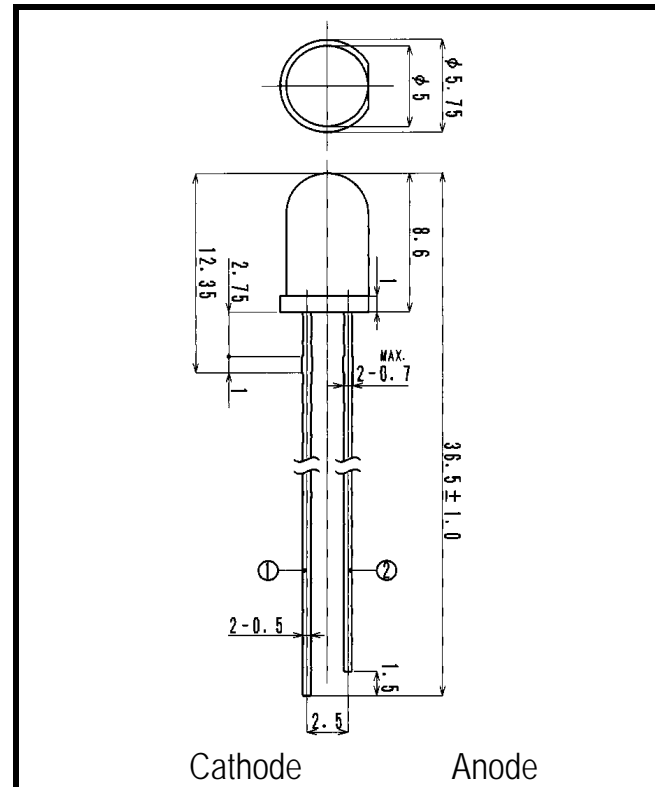
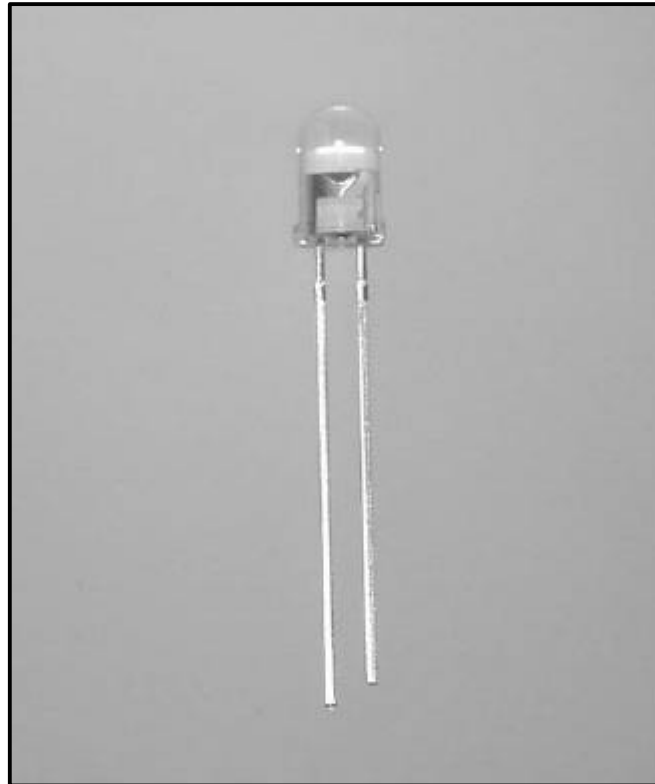

Cathode Anode  
Dimensions (Unit:mm)

- FEATURES**
- High-output Power
  - Narrow Beam Angle
  - High Reliability
- APPLICATIONS**
- Optical Switches
  - Bar-code Reader

## 2. ELECTRICAL & OPTICAL CHARACTERISTICS (Ta=25 °C)

ITEM	SYMBOL	CONDITIONS	MIN	TYP	MAX	UNIT
Power Output	PO	IF=50mA		10.0		mW
Forward Voltage	VF	IF=50mA		1.35	1.7	V
Reverse Current	IR	VR=5V			10	μA
Peak Wavelength	λ	IF=50mA		945		nm
Spectral Line Half Width		IF=50mA		50		nm
Half Intensity Beam Angle		IF=50mA		±12		deg.
Rise Time	Tr	IFP=50mA		1.0		μS
Fall Time	Tf	IFP=50mA		1.0		μS
Junction Capacitance	Cj	1MHz, V=0V		20		pF
Temp. Coefficient of PO	P/T	IF=10mA		-0.5		%/
Temp. Coefficient of VF	V/T	IF=10mA		-1.3		mV/

## 1. ABSOLUTE MAXIMUM RATINGS

ITEM	SYMBOL	RATINGS	UNIT
Forward Current (DC)	IF	100	mA
Forward Current (Pulse)*1	IFP	1	A
Reverse Voltage	VR	5	V
Power Dissipation	PD	180	mW
Operating Temp.	Topr	-20 TO 80	
Storage Temp.	Tstg	-30 TO 100	
Junction Temp.	Tj	100	
Lead Soldering Temp.*2	Tls	260	

\*1: Tw=10μs, T=10mS

\*2: Time 5 Sec max, Position: Up to 3mm from the body

SPECTRAL OUTPUT

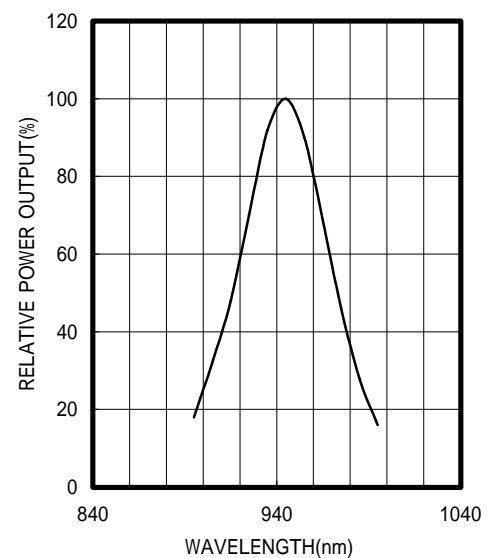

FORWARD I-V CHARACTERISTICS

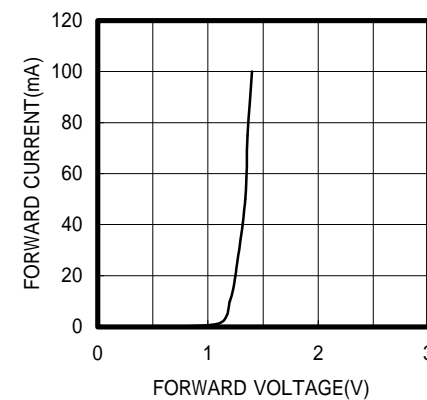

RELATIVE POWER vs FORWARD CURRENT

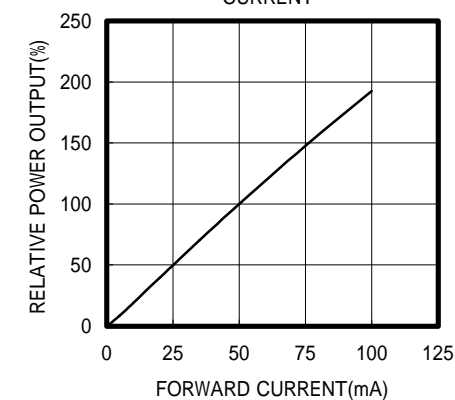

RADIATION PATTERN

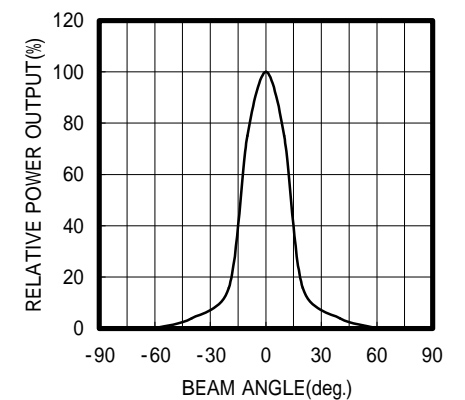

THERMAL DERATING COVE

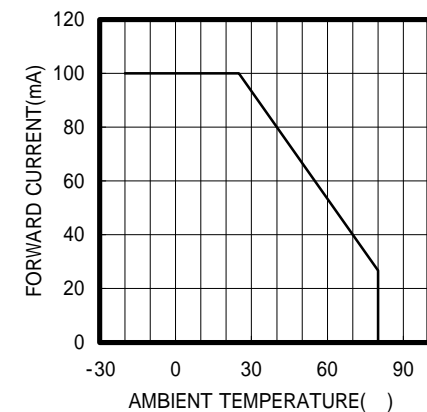

POWER OUTPUT vs TEMPERATURE  
IF=10mA

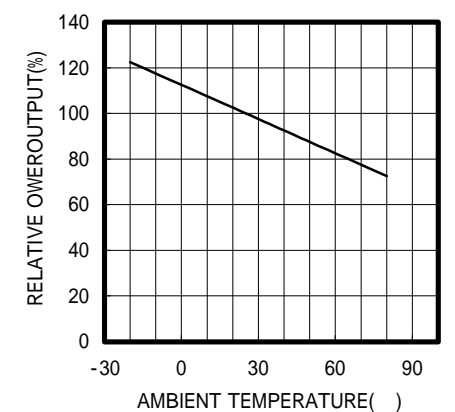

FORWARD VOLTAGE vs TEMPERATURE  
IF=10mA

